

Operators Manual
Fence, Guardrail, and Bridge Repair Truck
MC#05398
10/05/20



Contents

- Foreword: 1
- Disclaimer: 1
- Safety Information: 1
- Systems Overview: 2
- Cab Chassis: 4
- Crane: 6
- Under Deck Compressor Pneumatic Air System: 39
- Pressurized Water Tank System: 46
- Generator/Welder: 49
- AC Electrical Outlets: 50
- Oxygen Acetylene System: 51
- Liftgate: 52
- Front Workstation: 55
- Lighting Systems: 56
- Storage: 61
- 18 ft bed: 63
- Fire Extinguishers: 65
- Cone holders: 66
- Bridge Truck Options: 67

Foreword:

This manual provides all procedures and instructions needed for correct operation of the fence, guardrail and bridge repair truck. The procedures are designed to provide the best performance, longest life and utmost safety.

Disclaimer:

This manual is to be used as a general guideline on the proper use of the various systems and components of the Fence, Guardrail, and Bridge repair truck. Proper safety is to be used when operating heavy equipment. Please refer to Caltrans Code of Safe Operating Practices for safety related guidance. In general, hard hats, safety boots, gloves, hearing protection, and safety glasses are required to operate heavy equipment.

Safety Information:

Throughout this manual and on the machine, precautions are provided and classified by the words **DANGER - WARNING - CAUTION**, according to their extent of danger. The classification is as follows:



Danger indicates a hazardous situation which, if not avoided, could result in death or serious injury

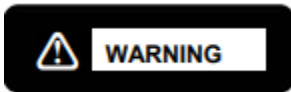

Warning indicates a potentially hazardous situation which, if not avoided, could result in death or serious injury.



Caution indicates a potentially hazardous situation which, if not avoided, could result in minor or moderate injury. It may also be used to alert against possible damage to the vehicle and its components.

We have made every effort to prevent accidents during operation; however, we cannot predict every kind of danger in all operating circumstances.

It is the user of the equipment who is responsible for ALWAYS paying attention when operating the equipment, as well as reading and understanding this manual enough to obtain the essential knowledge and skills fundamental to correct use.



- **Before operation, inspection or maintenance of the equipment, be sure to read and understand this manual and receive proper training. Incorrect operation or maintenance can cause accidents, serious injury and death.**
- **Always keep this manual on hand, so that you can immediately consult it when necessary.**
- **<https://equipment.onramp.dot.ca.gov/office-engineering-production/equipment-drawings-manuals-and-parts> for a replacement manual or contact your supervisor.**

Systems Overview:

How this truck is used:

The vehicle has three main purposes. Highway fence repair, guardrail repair, and bridge repair. It is equipped with various systems to get the job done. Below are the systems and components that are on this truck:

- Cab Chassis:
 - o 2020 Freightliner 114SD SBA, 236" WB, 170" CA
 - o Detroit Diesel DD13 12.8L, 435 HP @ 1625 RPM, 1900 GOV RPM, 1550 LB/FT @ 975 RPM
 - o Eaton Ultrashift Transmission
- Crane:
 - o Effer 265 Knuckle Boom Crane
 - Capacity: 11,800 lbs at 14'-4" to 6,300 lbs at 26'-5"
 - o Auger and Winch
- Under Deck Compressor Pneumatic Air System:
 - o Vanair shaft driven 185 CFM @100 psi
- Pressurized Water Tank System
 - o 100 gallons up to 55PSI
- Generator/Welder
 - o Miller Bobcat 250, Diesel
- Oxygen Acetylene system
- Liftgate
 - o Tommygate Liftgate with 1600 lb capacity
- Front Workstation
 - o Air, Water, 120V AC, and Vice Pocket.
- Lighting Systems
- Storage
- 18 ft bed
- Fire Extinguishers
- Cone Holders
- Bridge truck options
 - o Cement mixer, double stack tool boxes

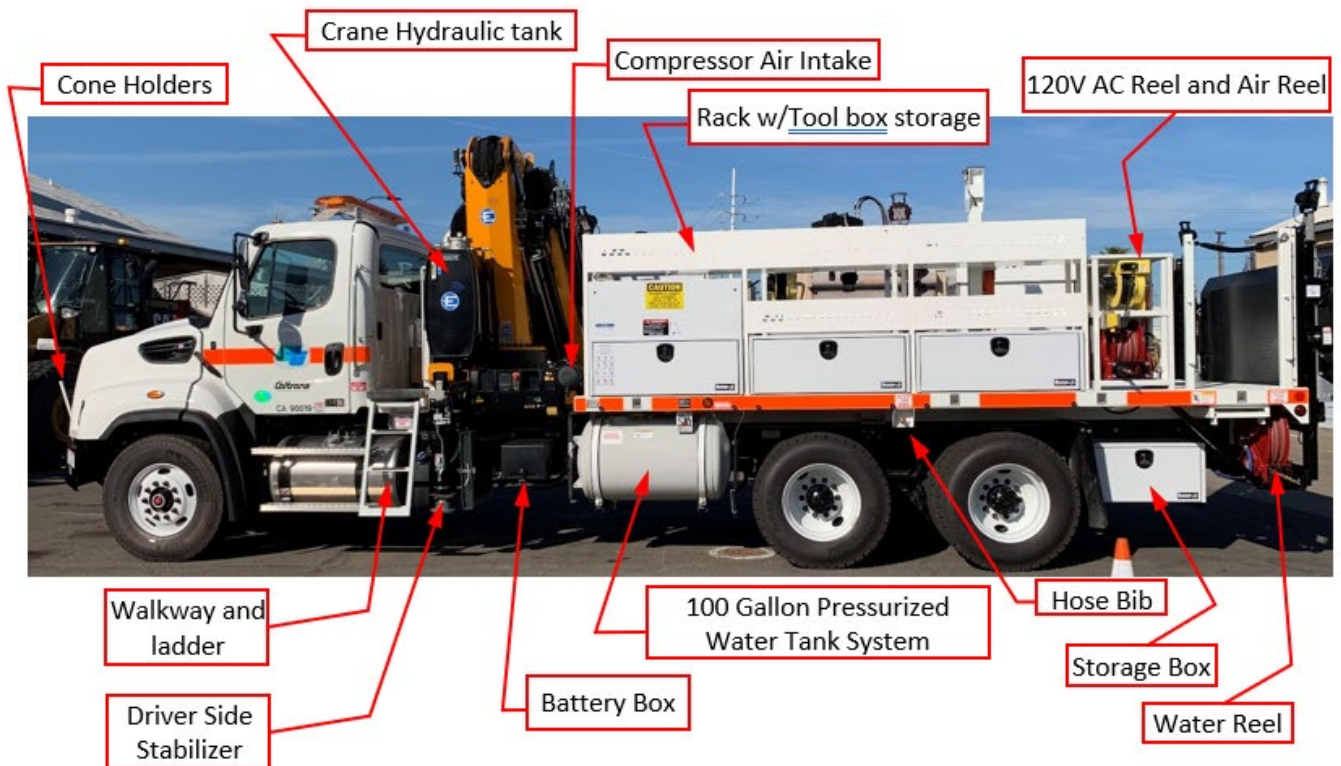
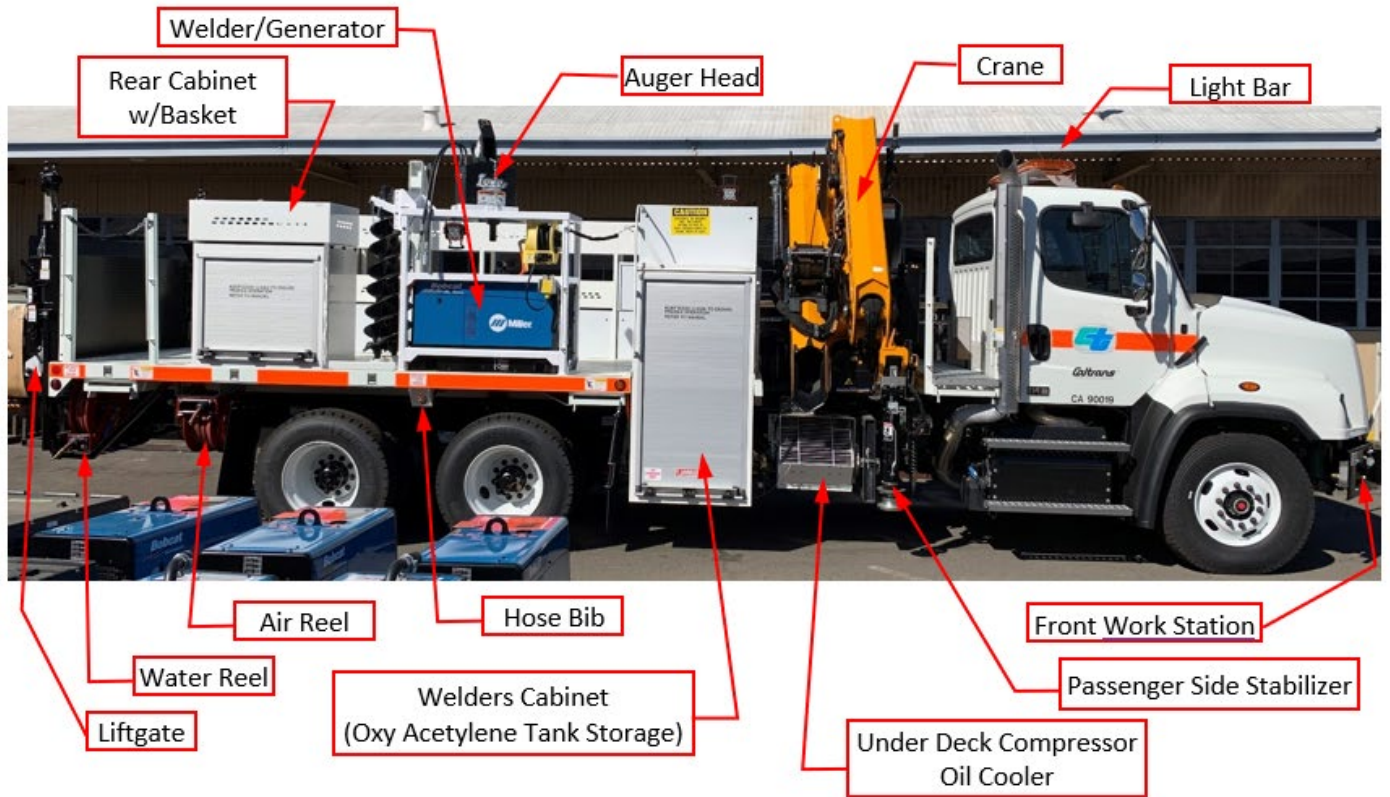

Cab Chassis:

2020 Freightliner 114SD Set-Back Axle (SBA), 236" Wheelbase

- 3-Axle
- Gross Vehicle Weight Rating (GVWR): 58,000 lbs
 - o Payload: 13,000 lbs
- Gross Combined Weight Rating (GCWR): 80,000 lbs
- Engine: Detroit Diesel DD13 12.8L, 435 HP @ 1625 RPM, 1900 GOV RPM, 1550 LB/FT @ 975 RPM



- Eaton UltraShift PLUS Transmission
 - o Web link: <https://www.eaton.com/Eaton/ProductsServices/Vehicle/Transmissions/heavy-duty-automated/ultrashift-plus-performance/index.htm#tabs-5>
 - o Video Link: <https://www.eaton.com/Eaton/ProductsServices/Vehicle/Transmissions/heavy-duty-automated/ultrashift-plus-performance/index.htm#tabs-5>
- Backup Camera and Monitor



Crane:

- Effer 265/2s Knuckle Boom Crane
 - The crane uses 24Vdc power. There is a 12/24V DC to DC converter behind the passenger seat.
 - The crane has a maximum capacity as follows,
 - Boom Load Capacity: 11,810 lbs at 14'-4" to 6,300 lbs at 26'-5"
 - Winch Load Capacity: With 3,965 lbs, with a range of 15'-6" to 26'-5".
 - The crane can be fitted with an auger head attachment and the following,
 - 9 - inch diameter auger
 - 12 -inch diameter auger
 - 24 -inch bit extension



CAUTION

- Untrained Operator Hazard
 - Do not operate the crane without proper training and full review and understanding of the Effer operator's manual.
- Follow instructions in Effer operator's manual for daily, frequent and annual inspections.
- Crush Hazard
 - Moving Boom could cause death or serious injury. Clear area prior to operating.
- Overload Hazard. Failure to select the appropriate load chart may result in death or serious injury.
- Entanglement hazard. Keep clear of rotating PTO drive shaft.

ZONE & LOAD CHARTS FOR CRANE ON 114SD, DIESEL TRUCK

EC265-2S WINCH USE

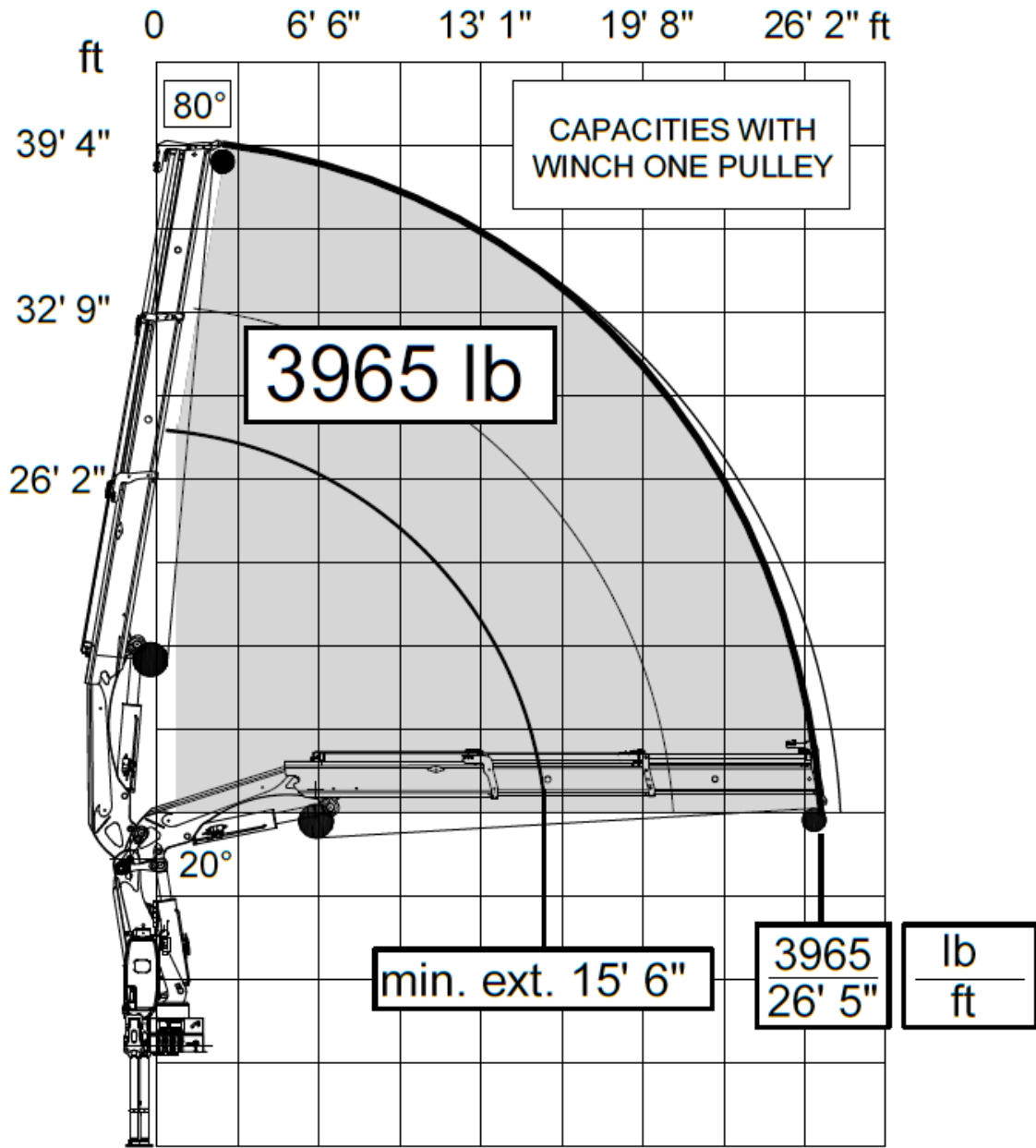

991124160-A

EC265-2S

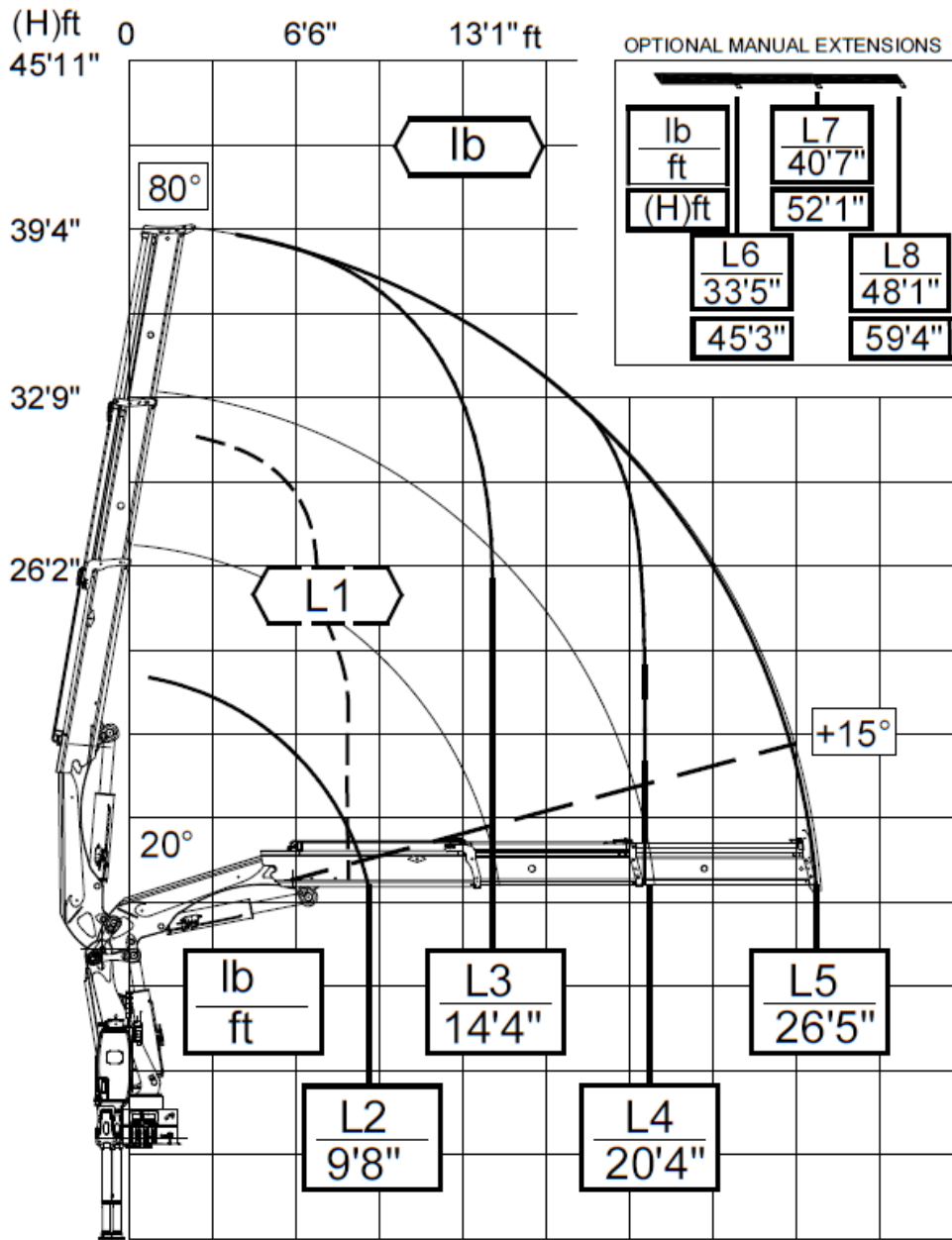

REFER TO TRUCK CONFIGURATION DIAGRAM AND LOAD CHART TO DETERMINE LOADS L1 - L8.

991124158-A

EC265-2S

Truck Configurations	Loads at Stated Operating Radii (LB)							
	L1	L2	L3	L4	L5	L6	L7	L8
CONFIG 1 ZONE A	N/A	N/A	9060	6240	4760	N/A	N/A	N/A
CONFIG 1 ZONE B	N/A	N/A	11810	8220	6300	N/A	N/A	N/A
CONFIG 1 ZONE C	N/A	N/A	11810	8220	6300	N/A	N/A	N/A
CONFIG 1 ZONE D	N/A	N/A	11810	8220	6300	N/A	N/A	N/A
CONFIG 2 ZONE A	N/A	N/A	9060	6240	4760	N/A	N/A	N/A
CONFIG 2 ZONE B	N/A	N/A	6570	4450	3370	N/A	N/A	N/A
CONFIG 2 ZONE C	N/A	N/A	11810	8220	6300	N/A	N/A	N/A
CONFIG 2 ZONE D	N/A	N/A	6570	4450	3370	N/A	N/A	N/A
CONFIG 3 ZONE A	N/A	N/A	9060	6240	4760	N/A	N/A	N/A
CONFIG 3 ZONE B	N/A	N/A	2890	1810	1300	N/A	N/A	N/A
CONFIG 3 ZONE C	N/A	N/A	11810	8220	6300	N/A	N/A	N/A
CONFIG 3 ZONE D	N/A	N/A	2890	1810	1300	N/A	N/A	N/A

Truck Configuration Placard: 991062039

Crane Reach Placard: 991124158

This placard must be installed in conjunction with the specified Truck Configuration Placard and Crane Reach placard.

991124937-A

Caltrans Note: Size of Front Zone 'A' will reduce as stabilizers are reduced from 100% to 0%.

- At 100% stabilizers, Front Zone is between 50° & 316°.
- At 50% stabilizers, Front Zone is between 32° & 332°.
- At 0% stabilizers, Front Zone is between 14° & 348°.

EFFER CRANE TRUCK CONFIGURATIONS

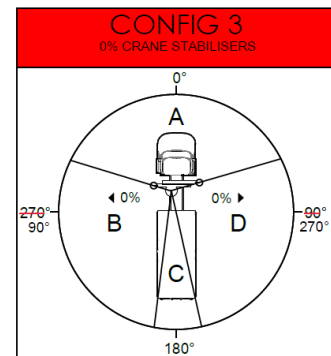
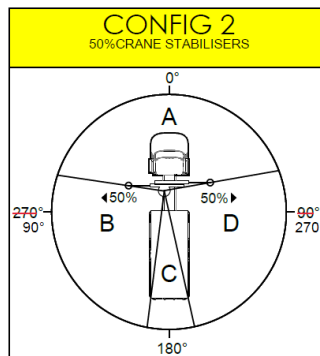
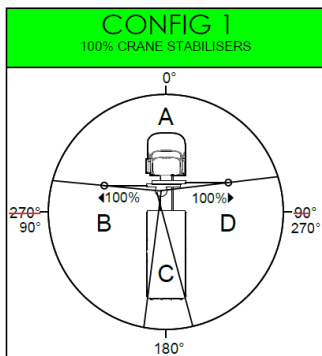

NOTE: ALL STABILISERS MUST BE COMPLETELY DOWN. REFERENCE GRAPHIC FOR STABILISER CONFIGURATION.

NOTE: REFER TO THE CRANE MANUAL FOR CORRECT CRANE SET UP

NOTE: CHECK TIRE PRESSURE AGAINST THE CERTIFICATION DECAL, LOCATED IN CAB ON DRIVERS SIDE DOOR.

991062039-B

- **General Crane Info:**

- The crane is equipped with an electronic stability control system, Progress 2.0. The system is divided into 4 zones – Front, Left & Right Sides, and Rear. The crane will reduce load (%) capacity as the stabilizers are set closer to the truck. The front zone is reduced when stabilizers are set closer to the truck.
- The remote is the sole primary means of operating the crane and stabilizers. **Please treat the remote with care and be sure it is in the cab before moving the truck. Replacement cost of remote is approximately \$10,000.**
- This crane model does not allow auxiliary (emergency) controls to be enabled during the crane’s normal use. Enabling the auxiliary controls is a multi-step process and requires disabling the crane’s computer, safety systems, and remote. The auxiliary controls are for the sole purpose of stowing the crane if the remote cannot be used with battery or corded connection. Refer to Effer’s instructions for required operating procedures.

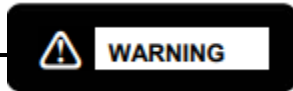

! Never use the crane’s auxiliary controls when the crane remote and Progress system are On.

- **Maintenance**

- See Use & Maintenance Instructions for recommended lubrication and inspection intervals.

- **Effer Operator Manuals (2):**

- For more detail on the remote control, refer to the Progress 2.0 Crane Control System manual.
- For instruction on auxiliary controls, refer to Ch. 6 of the Use & Maintenance Instruction manual.

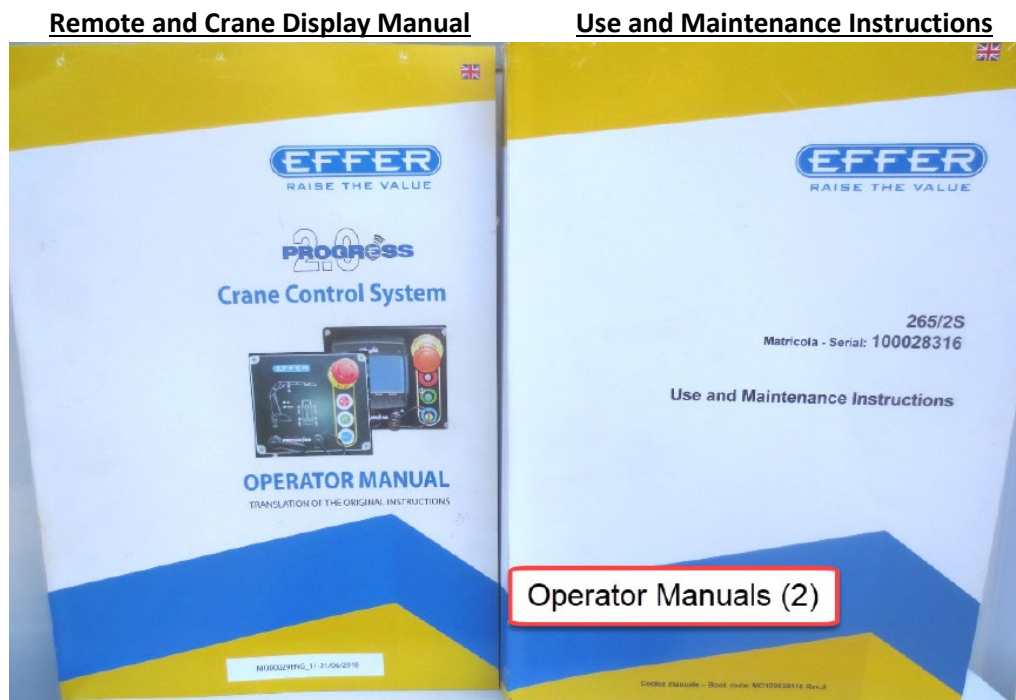

- Remote, Batteries, and Charger:

- The remote can be stowed in the cab's center console box.



- When using the battery charger, ensure the 12V adapter is fully connected to the console and the charger is receiving power. Ignition starter key must be cycled to On/Accessory to waken the 12V outlet.



- If both batteries become discharged, use the corded cable supplied in the base of the crane turret to connect the remote.



- The box can be unlocked with a flat head screwdriver or coin.
- **! Keep the lid of the box down to avoid damaging the crane's hydraulic tank during operation.**

- **Start up Operation:** See Effer manual for in-depth instruction.
 - o Ensure the ball valve supplying oil to the crane's hydraulic pump is fully open as shown.



- o Check Oil Level.



- o Set Wheel Chocks
- o Engage PTO:



- Be sure to follow the PTO engagement instructions to prevent damage to the transmission and PTO.
- **PTO Safety Interlocks**
 - o If any of the PTO switches are on when trying to turn on the truck, after the truck starts the indicator will flash until the switch is turned off. This prevents grinding of PTO if someone accidentally leaves the switch on after turning off the truck.
 - o PTO has 2 preset speeds: 900 rpm any time crane PTO is engaged, 1250 rpm only when JUST THE COMPRESSOR PTO is on. No need to press a switch, truck will change speeds automatically.
 - o Any time truck is shifted out of neutral, parking brake released, or foot put on the brake pedal, truck will drop to idle and any engaged PTO will disengage.
- **Crane Safety interlocks**
 - o If any stabilizer foot is down, the engine will shut off if you try to release the parking brake to prevent the truck from moving.

- Crane PTO Engagement and Disengagement:

o To Engage PTO

- Set Parking Brake



- Press and hold Foot Brake



- Shift to "D" Drive and wait a moment for the transmission to respond.



- Switch PTO to on position



(continued next page . . .)

- Return the shifter to “N” Neutral



- **Slowly** let go of foot brake



PTO will now engage, and engine speed will automatically raise to 900 RPM

- To Disengage PTO

- Press and hold the footbrake and switch the PTO to the Off position.

Engine RPM will ramp down when footbrake is pressed.

- **Slowly** let go of the footbrake and ensure the PTO does not re-engage and the engine RPM stays at low idle.

- Unlock Crane Display: Twist the emergency stop button (clockwise) on the driver side display.

Note: Sometimes, it may be necessary to press the Power/Reset button when wireless connection to the remote is lost. There is momentary delay when powering the display Off/On.

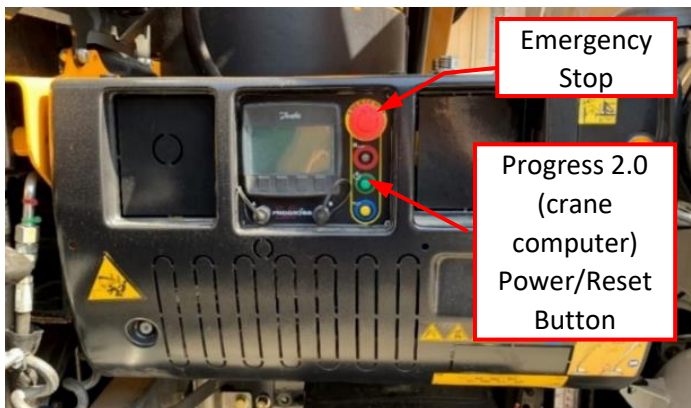

***** Note: The E-stop at the upper controls is a Pull-to-reset (not a twist-to-reset) type button. It functions independent of the crane computer being On/Off. *****



- Enable stabilizer control
 - The [Crane] or [stabilizer] selector is on the remote. This 2-position switch is self-locking. The switch must be lifted and toggled simultaneously to switch positions. Switch to stabilizer mode.

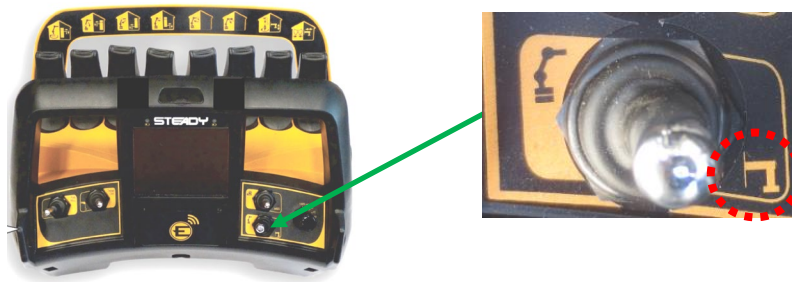

- Link wireless remote
 - As-necessary, twist the E-stop button (clockwise) on the remote to turn the remote display On.



- Push the reset/start button on the left side of the remote to link to the crane. As prompted by the remote, push the start button a second time to link to the crane
- The remote will be linked to the crane when the remote display shows “PRESS ENTER” or “STAB ALLOW.” If display shows “CRANE LOCKED”, ensure remote is switched to stabilizer mode.



OR

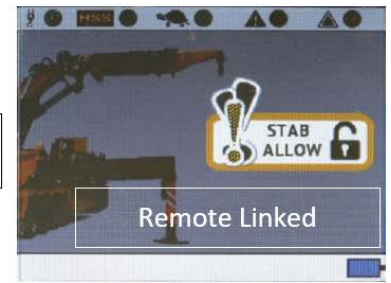

Note: The Black knob on the right side is the Enter and Scroll button used to scroll through and select (when pressed) information such as stabilizer %, boom angle, turret angle.

- Set out the factory-supplied stabilizer pads for each stabilizer.
- At each stabilizer, place stabilizer valve lever to the unlocked position.

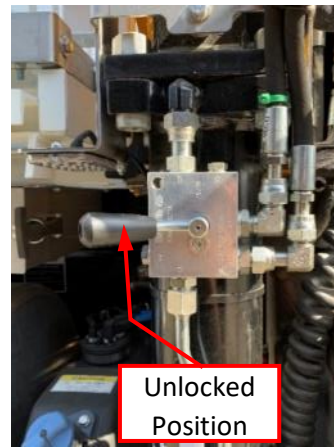
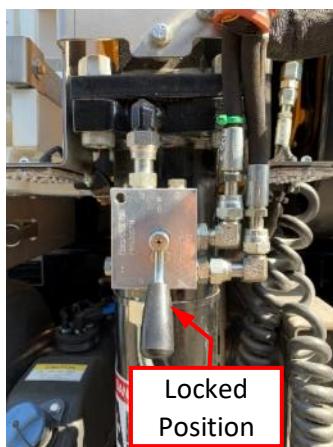

- At each stabilizer, lift the mechanical stabilizer latch to the unlocked position. Note: The latch will prop itself up when the latch is raised.



! To prevent injury or damage, DO NOT ATTEMPT TO MANUALLY HOLD THE LATCH WHILE DEPLOYING STABILIZERS! DAMAGED/FAULTY LATCHES MUST BE REPAIRED PROMPTLY!



- Enable the stabilizer beams using the buttons shown below at each stabilizer. The buttons are to help prevent unintended stabilizer movement. The buttons will time-out after about 60 seconds. The buttons do not need to be pressed for raising/lowering stabilizer jacks.

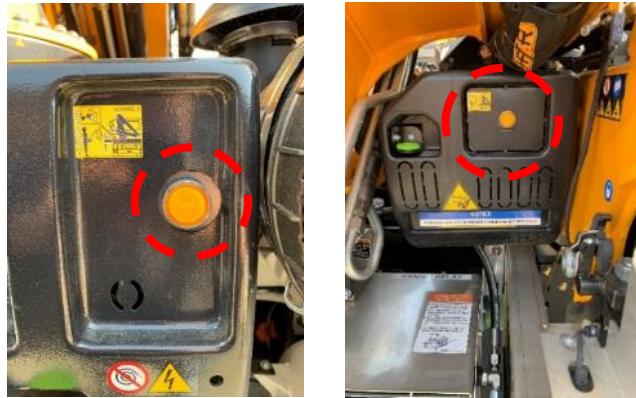

- Set stabilizers. Stabilizer control requires 2 levers at a time.
 - Which side of the truck – [Passenger side] or [Driver side] ?
 - Which stabilizer function – [Stabilizer Jacks] or [Stabilizer Beams] ?
 - **Push** levers away to deploy. **Pull** levers in to stow.

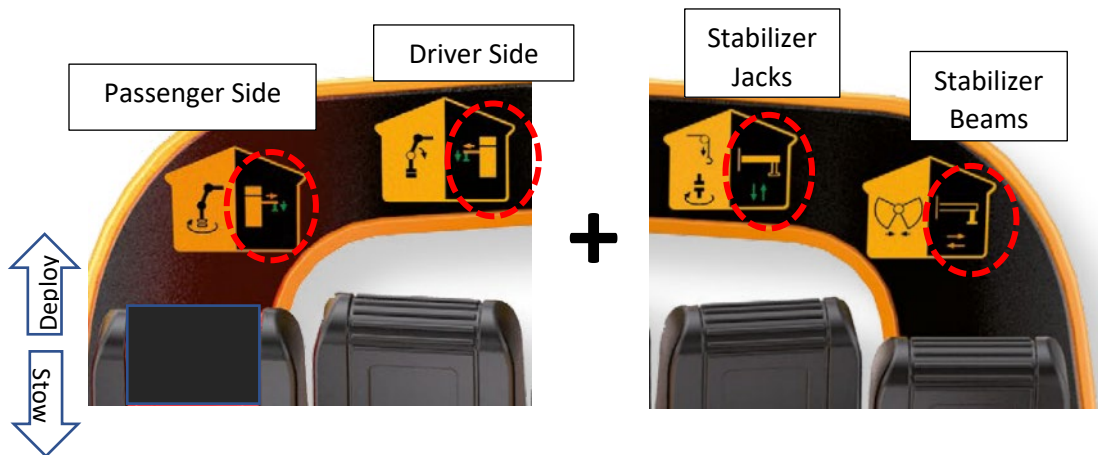

- When setting the stabilizer jacks, the crane must detect there is down pressure for the crane to unlock and remain operable. Ensure the stabilizers have adequate down pressure. This will be visible as the top of the stabilizer beam will contact its casing.
- Confirm the crane is level. Levels on each side of truck should be nearly centered in bulls eye without lifting tires off the ground.



- Select [Crane] Mode on Remote
 - Lift and toggle the selector switch from [Stabilizer] to [Crane] mode. Take care not to accidentally bump any levers.

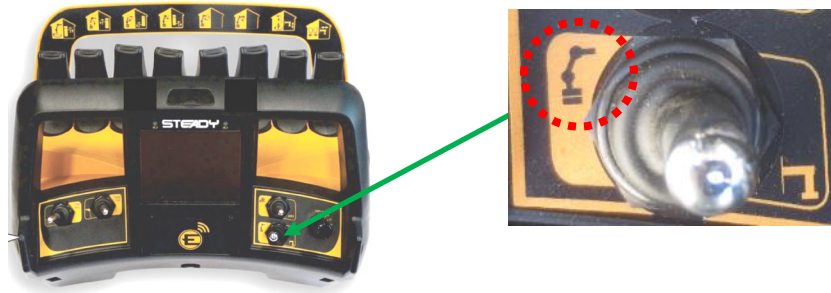

CAUTION

When performing other tasks, it is advised to disable the remote using the Red E-stop on the side of the remote. This will prevent unintended movement of the crane should levers be bumped by mistake.

- Adjusting the Crane Speed
 - The crane speed should be reduced in some cases including when personnel are near the crane or when the operator is still getting used to this particular crane model.

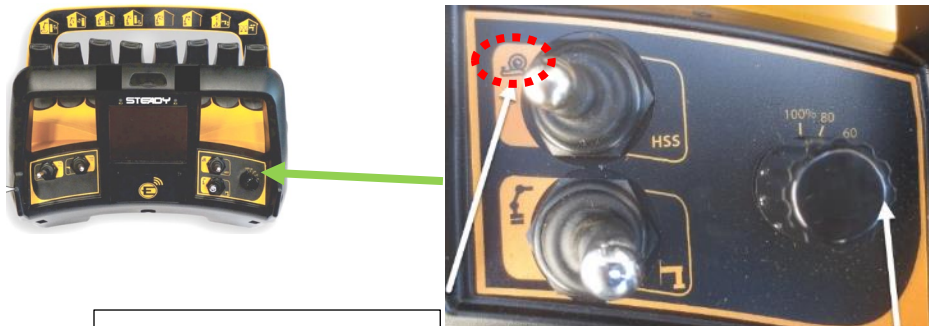

1) Select [snail] symbol.

2) Adjust % speed.

- Unfolding the Crane from Knuckled, Behind-the-Cab Stow Position
 - Familiarize yourself with the remote levers shown below.

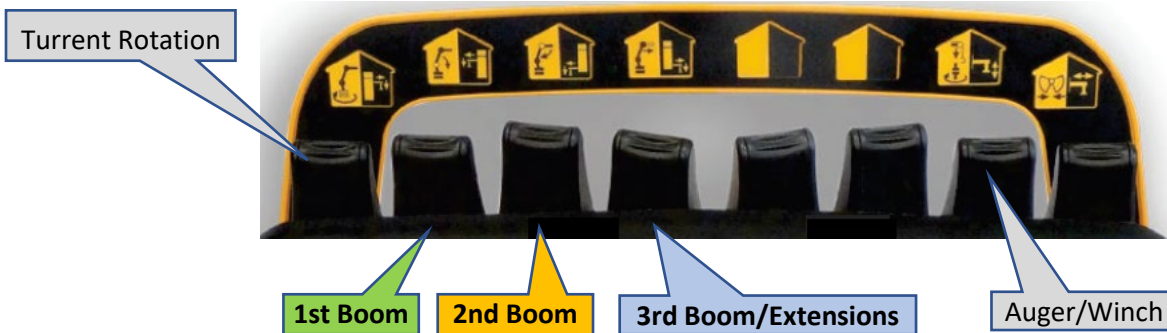

- Go to the passenger side of the crane for viewing the boom.



- Ensure the 2nd boom is clear by pushing forward on the 2nd boom lever.
- Slowly raise the 1st boom by pulling the lever toward you.



- When the 1st boom is clear enough to unfold the 2nd boom, slowly raise the 2nd boom by pulling the lever toward you.



- When the 2nd boom is clear, adjust the 1st boom to nearly 20 degrees. Refer to Yellow arrow [>] [<] markings on the turret and 1st boom. You can also view the boom angles on the remote. For best performance, try to keep the 1st boom nearly 20 degrees for operation.

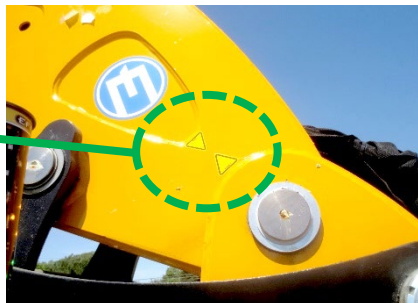

- Adjust the 2nd and 3rd booms as-needed.

- ! If the crane is operated at or up to its prescribed load limit (shown as % on the driver side and remote crane display), the crane may stop abruptly and cause the remote to lose connection. If connection cannot be re-established from the remote, **it may be necessary to turn Off the crane computer (Green button on driver side crane display), then turn the display back On to reset the crane computer.**

- **Boom Hook**

- When attaching the boom hook, be sure to select the correct components as shown below. Use the 11.5-ton rated boom hook. It is larger than the winch hook.
- Do not use the square-head pin or the smaller diameter pin to attach the boom hook. The correct 30 mm pin has a snug, sliding fit.

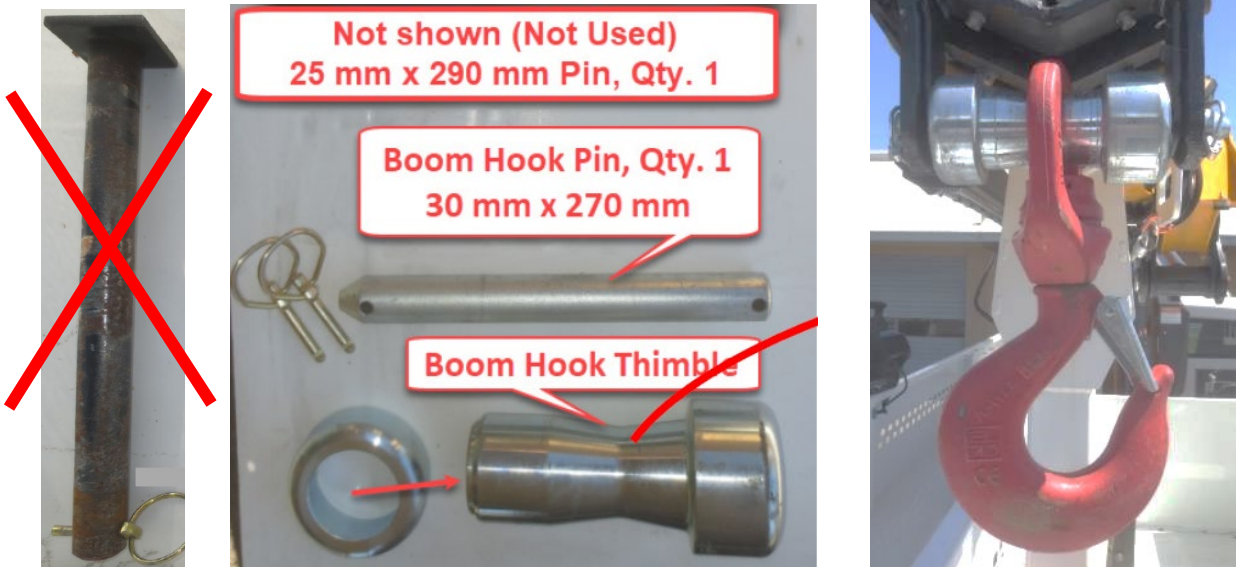

- **Winch**

o Winch Pulley

- Maneuver the boom close to the pulley. Attach the pulley to the end of boom using the galvanized 30 mm x 270 mm pin. The correct pin has a snug, sliding fit. Never use the smaller diameter pin or the square-head pin from the auger to attach the winch pulley.

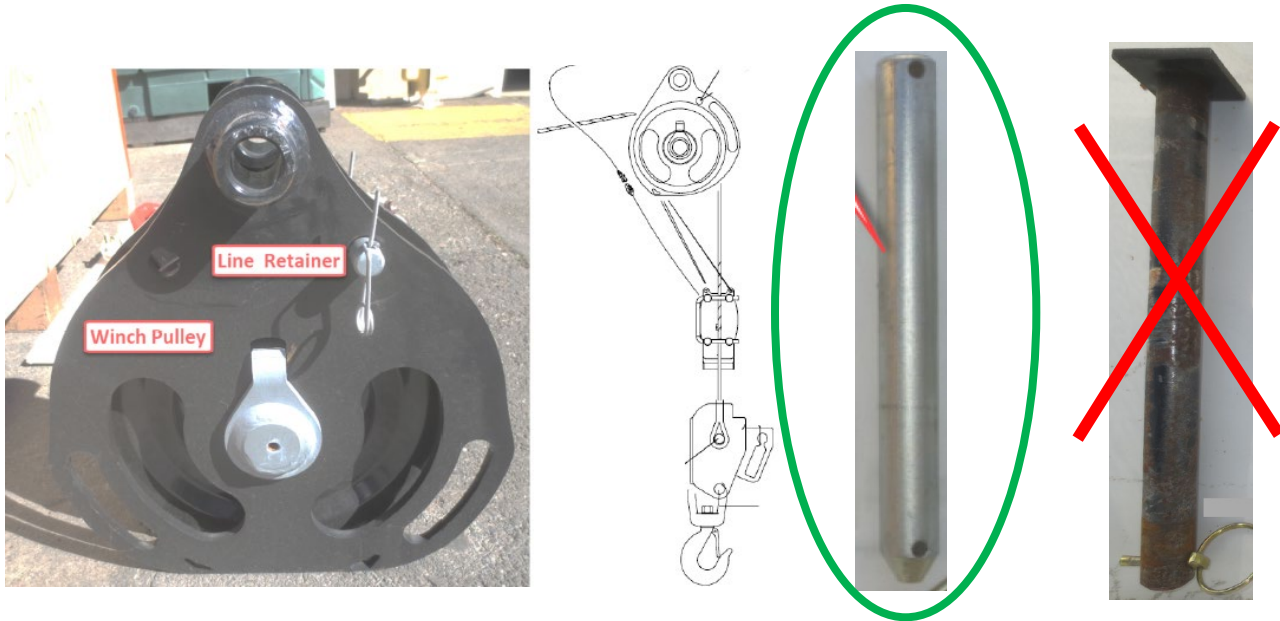

o Downhaul Weight & Anti-2-Block Switch

- Latch the anti-2-block switch to the pulley.

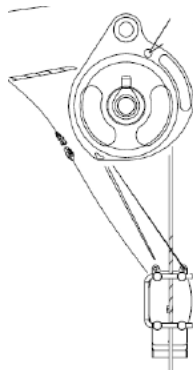

- Remove the anti-2-block jumper-cap at the end-of-boom and connect the anti-2-block switch. Do not lose the jumper cap.

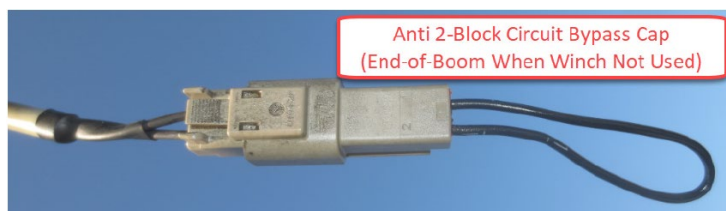

- Assemble the downhaul weight and winch hook. There is a separate, 8-ton rated winch hook. When attaching the winch, be sure to use the correct supplied thimble and hook.

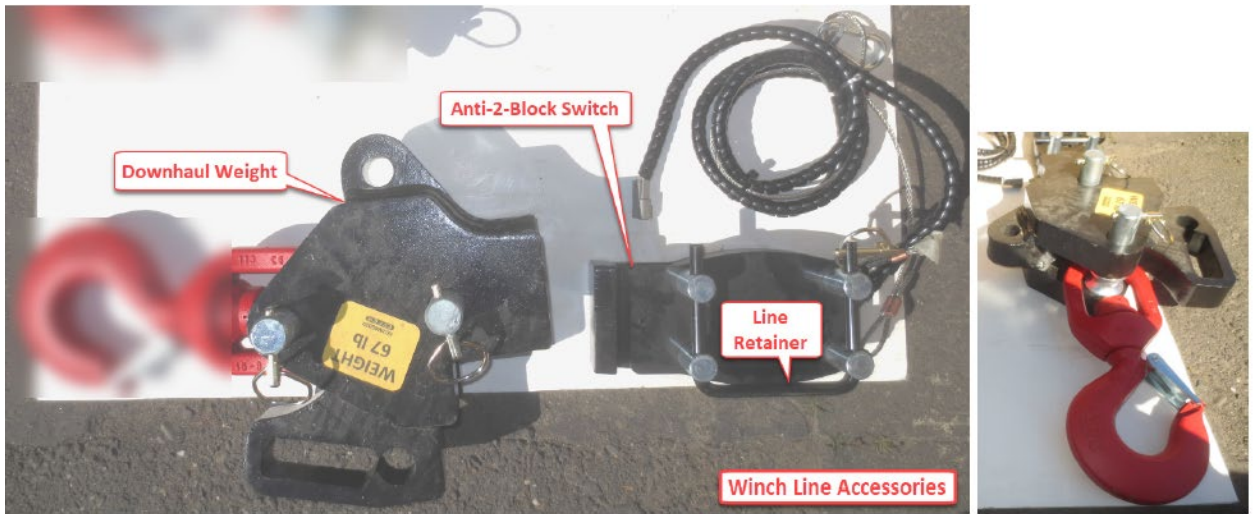
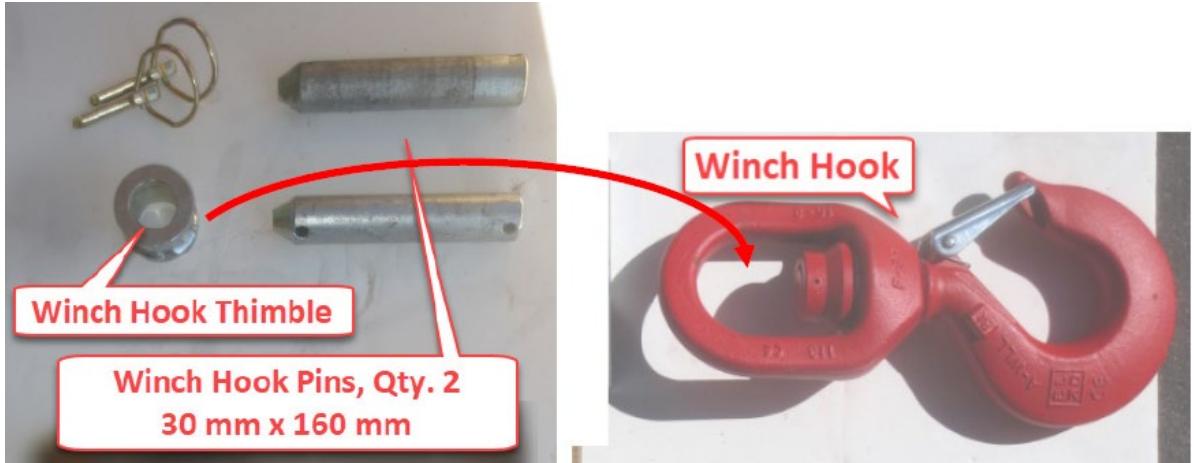

- **Winch Control**

- Select [Winch] at the Winch-Auger selector switch on the remote.
- Watch the winch drum closely and very slowly push the control lever a small amount to confirm direction of wire rope deployment.

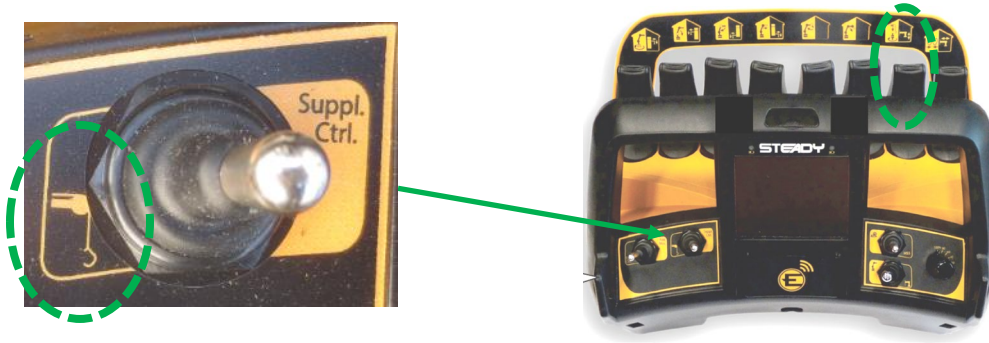

- Unlatch the carabiner and cable from stowed position.

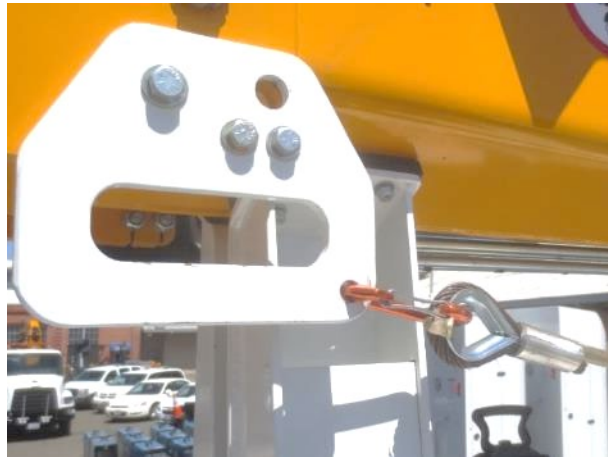

- Winch Wire Rope Connection

- Feed the wire rope through the pulley and anti-2-block switch.

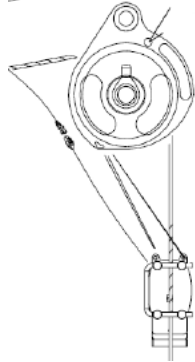

- Connect the wire rope to the downhaul weight.
- Be sure to use the supplied retaining (cotter) pins, especially for the line retainer bar on the anti-2-block switch.

- Winch, After Use

- After the winch accessories are to be removed for stowing, be sure to replace the anti-2-block jumper-cap at the end-of-boom. The supplied jumper-cap must be installed when the winch is not used.

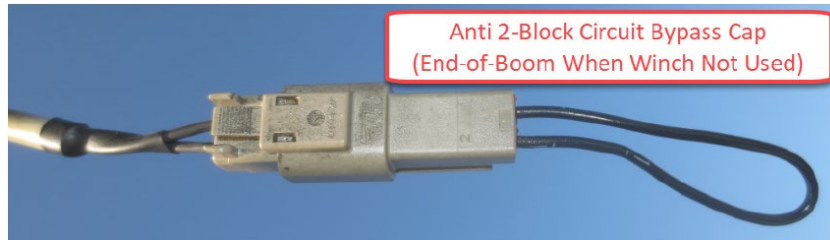

- Re-stow the wire rope to the supplied bracket.

! Do not apply excess tension to the wire rope as components may get damaged.

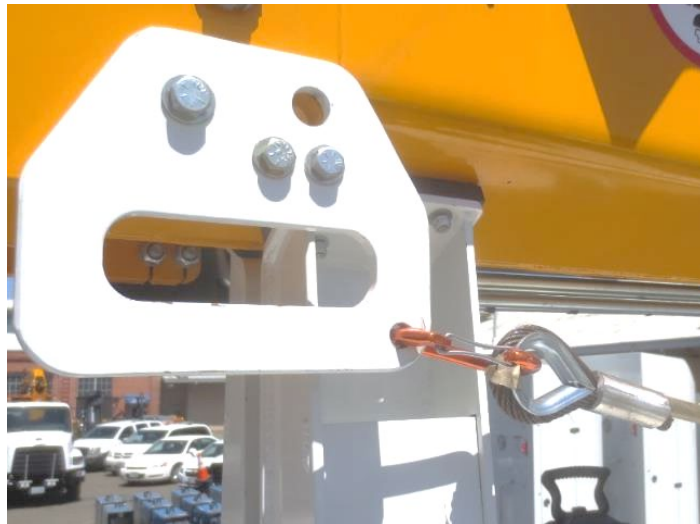

- Auger Use

- Auger Installation

- Maneuver the boom near the auger head adapter.

- Attach the auger head adapter and auger head using the supplied pins shown below.
- Connect the 2 flush face coupler hydraulic lines.



- **Auger Control**

- Be sure to select [**Suppl. Ctrl.**] at the Winch-Auger selector switch on the remote.
- Push/pull the winch-auger lever to operate the auger.

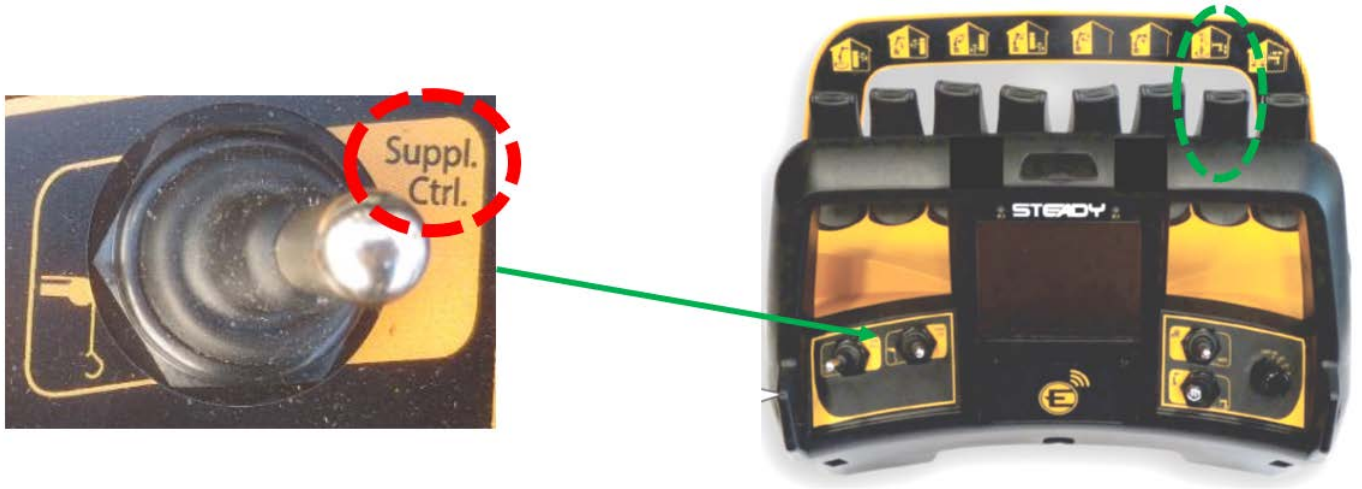

- Boom Stow

- o Rear Boom Rest or Behind-the-Cab Stow



- o Rear Boom Rest: When lowering the boom into the rear boom rest,

- ! Be sure the boom is centered in the boom rest.
- ! Watch for adequate clearance between the winch reel and top basket when lowering!
- Attach ratchet strap hook and tighten down.
- ! Do not overtighten!

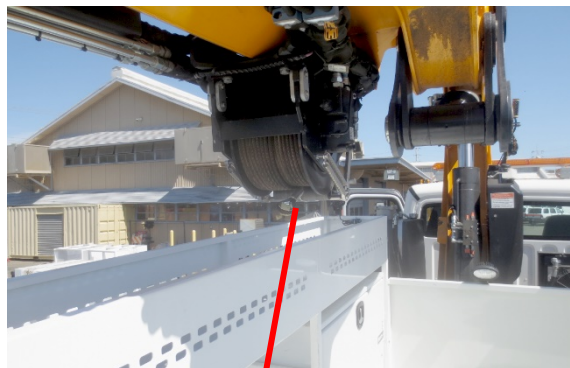

- Behind the Cab Stow
 - Retract extensions (boom 3).
 - Rotate boom to passenger side.



- Raise 1st boom enough to fold boom 2.
- After folding boom 2, lower the 1st boom and adjust the turret rotation angle as-needed to center the boom as shown for stowing.
- Lower the 1st boom to its stop.



- Crane Interlock - Boom and Stabilizer Foot

- The truck is equipped with boom and stabilizer foot interlocks. At over 3 mph, the engine will shut down if the boom or stabilizer feet are un-stowed.



- Boom Interlock, Stow Sensors

- The boom stow interlock sensors are located at the boom rest and behind-the-cab (for knuckled position).

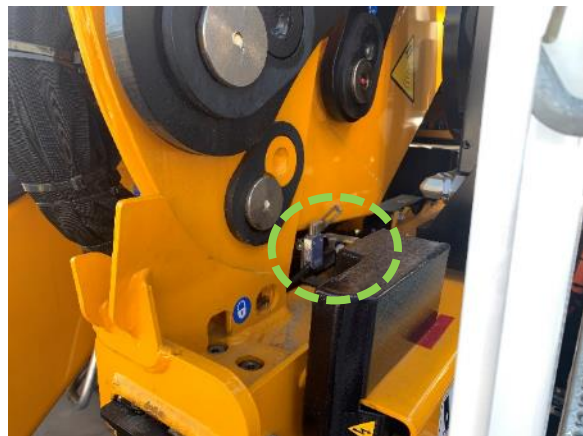

- Stabilizer Foot Interlock, Stow Sensors

- The stabilizer interlock sensors are at each stabilizer foot. Return the stabilizer valve lever to the locked position after stowing to keep the stabilizer foot from creeping down.

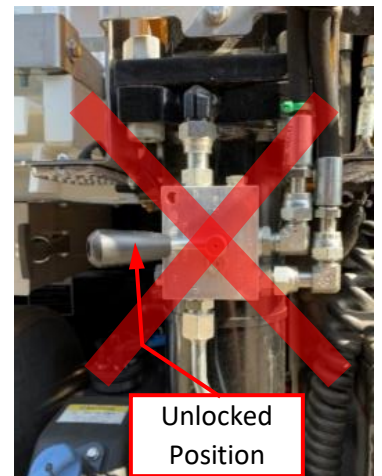
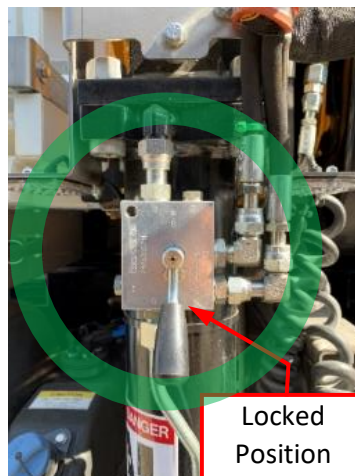

Enabling Auxiliary (Emergency) Controls:

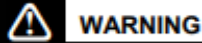

! Never use the crane's auxiliary controls when the crane remote and driver side display are On.

- **The auxiliary controls are for stowing the crane only if the remote is not functional** with batteries or corded connection. Enabling the auxiliary controls requires turning Off the crane's safety systems.

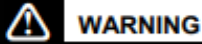

! Emergency stop buttons at the crane remote and driver side display will not function once auxiliary controls are enabled.

- **! Tools Required:** Enabling auxiliary controls requires basic tools that should be kept with the truck.
 - [Upper Cover] 5 mm Allen Wrench or 10 mm Socket depending on production series.
 - [Upper Cover & Bypass Screw] 13 mm or 1/2 inch Ratcheting Socket or Box Wrench.
 - [Stabilizer Valve] Screwdriver (#1 or 1/8"), overall length 6 to 7-1/4 inch.
 - Needle nose and diagonal cutting pliers.
- The following steps are from the Effer manual. Some photos and notes have been added.

Safety devices	06	5		MO00041ENG_5
----------------	----	---	--	--------------

By-pass the PROGRESS device (crane - stabilisers)

2nd - BYPASS procedure - PROGRESS device off

- Turn off the PROGRESS device by the switch ON / OFF (B).

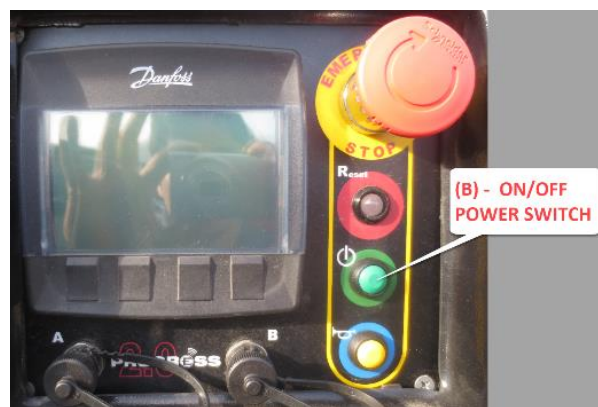

! Be sure the crane's Progress display is powered Off if the truck or PTO are re-started at any point during the auxiliary controls procedure.

WITH DANFOSS CONTROL BANK

- Remove the control bank safety cover (D).

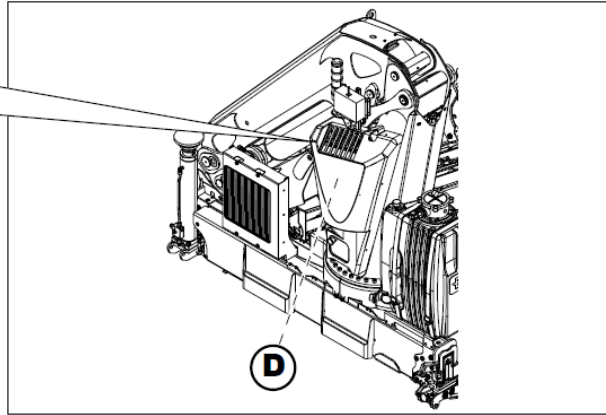

! NOTE: Engaging the auxiliary controls in the next steps will allow hydraulic flow through the control bank. The E-stop at the auxiliary controls can be pushed to block hydraulic flow to the control bank. (Pull-to-Reset) Do not disconnect the E-stop connector; otherwise, the crane will not function.



With the cover removed, locate the main solenoid valve (knurled knob) on the right side of the control bank.

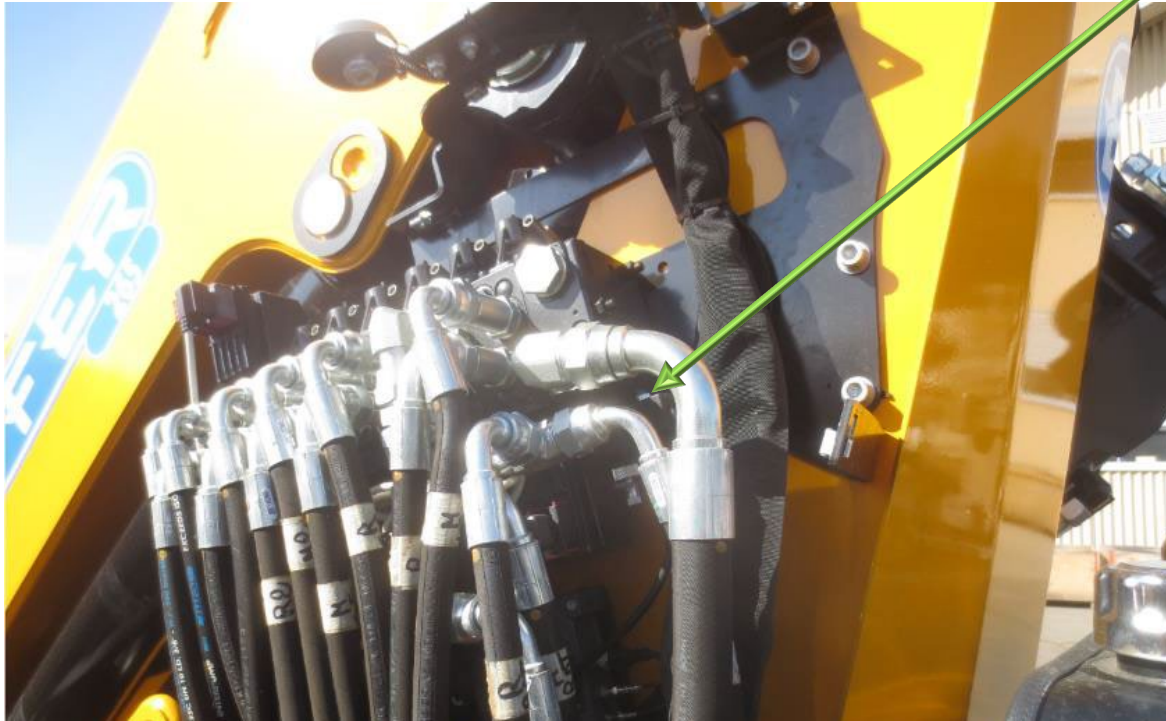

- Activate emergency operation of the main solenoid valve (C) - IF FITTED -

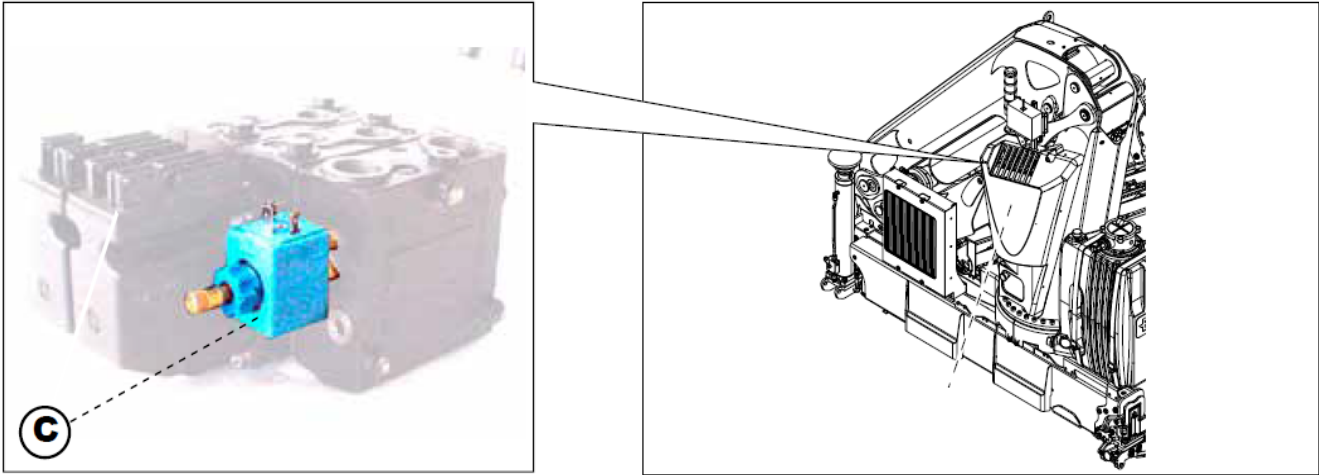

The knurled spool present on the valves block has two positions:

C1. lifted for normal functioning;

C2. lowered for functioning in **emergency**.

Position the spool on position C2.

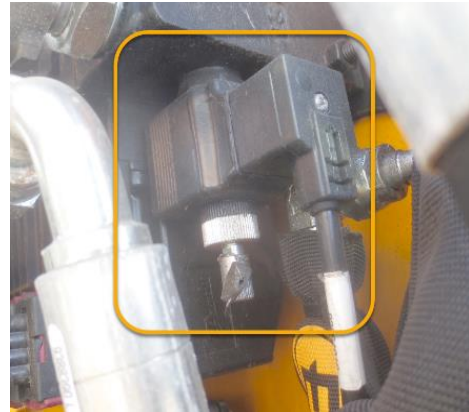
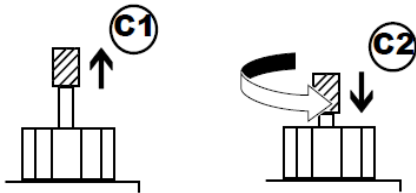

Locate the hex head screw on the other side of the control bank.

Hex Head Screw

Lead Seal



- Remove the sealing on shaft (E).

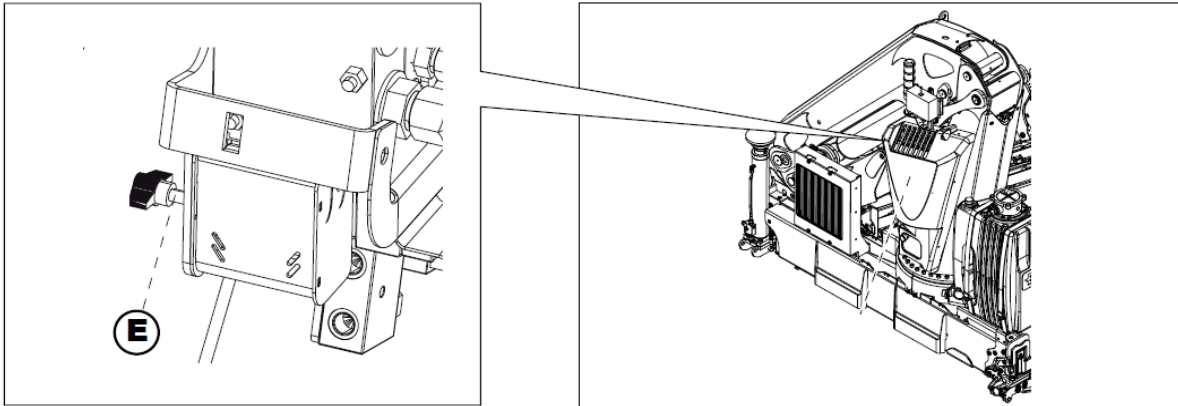

- Tighten the shaft (E) until it stops (Fig. 2) by manually turning the knob (F) or acting on the screw using a special wrench.
- In this condition all stabilizers operate to the maximum speed.
- Move the stabilisers using the solenoid valves unit, as indicated in the “Stabilisers movement in an emergency” paragraph.
- Unscrewing the shaft (E) of two turns the crane operates.
- Move the crane using the crane command levers on the manual commands unit (see chap “4 - Commands and tools”).

NB: the levers are not assembled; they are supplied. They should be dismantled after use.

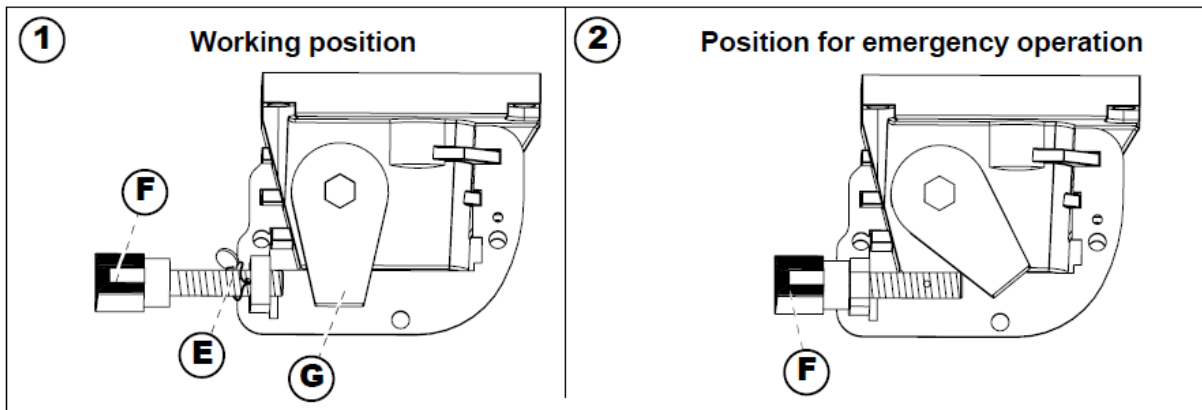

CAUTION

After that, IT IS STRICTLY PROHIBITED to execute any lifting or handling operation with the device excluded.

Immediately thereafter, consult an EFFER service center. The manufacturer declines any liability for damage caused by failure to respect this warning.

Note Once the correct crane operation is restored by the service center, the shaft (E) must be turned to its rear position and must be locked by the plumbing (Fig. 1). Check that the travel of the lever (G) of the control bank does not interfere with the threaded portion of the knob (F).

Outriggers movement in emergency

Procedure for solenoid valves unit without command lever

1) Dismantle the casing of the stabilisers control unit (A) casing placed on the side of the counter-frame.

2) Activate emergency operation of the main solenoid valve.

The knurled spool present on the valves block has two positions:

2a. lifted for normal functioning;

2b. lowered for functioning in emergency.

Position the spool on position 2.

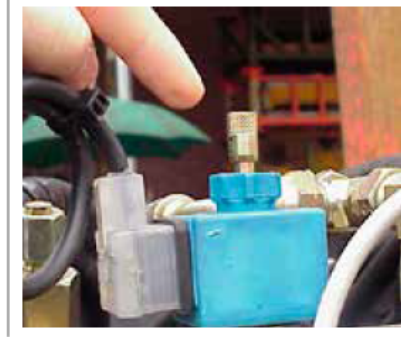
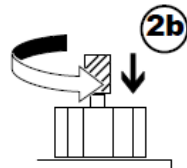
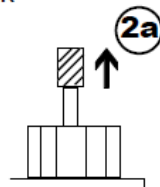

3) Identify the reel corresponding to the element to move (beam - foot).

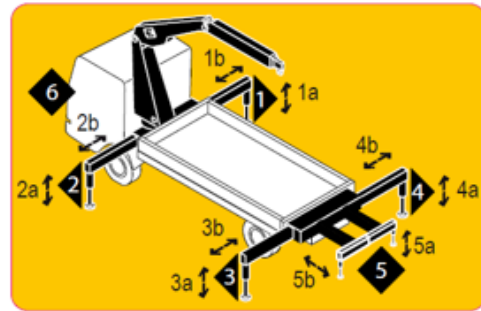
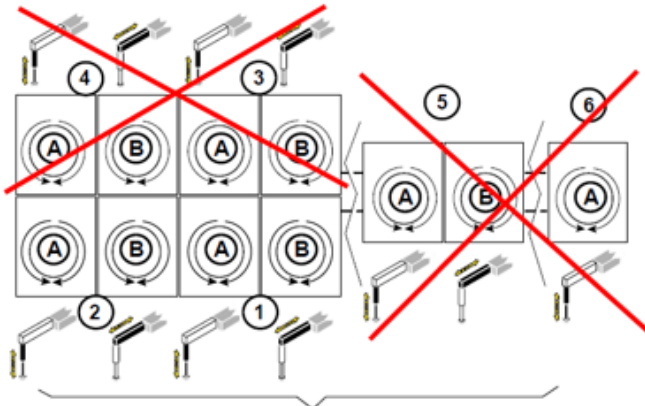

Safety devices	06	11	EFFER	MO00041ENG_5
----------------	----	----	--------------	--------------

Outriggers movement in emergency

4) Movement of the element.

4a. ~~Screw in the spool of the reel~~ corresponding to the stabiliser or the jack on the foot you want to move (see diagram).

This crane has Red knurled knobs.
 - Twist counter clockwise to enable function.
 - Twist clockwise (finger tight) to disable function.

4b. Press the spool cursor for up/down or return/ lift with a sharp object.

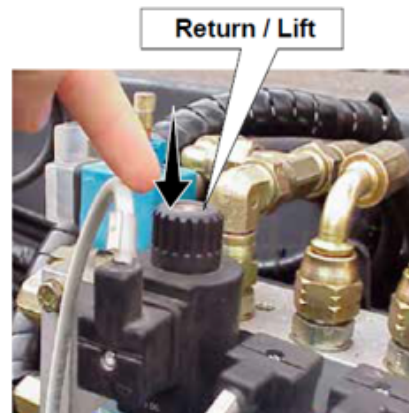
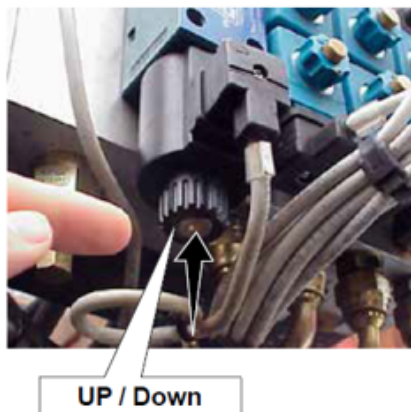

Having terminated the closure phase of all the stabilisers, you must re-condition the valves and re-assemble the casing to protect the electrical and hydraulic parts of the system.

 **CAUTION**

Faced with anomalies, immediately consult an EFFER support centre to restore the parts in the correct work positions. The manufacturer declines any responsibility for damages caused due to the non compliance with this warning.

- **NOTE: The E-stop button at driver side crane display (and remote) must be cycled (reset) to restore Progress control system once auxiliary control valve settings been have been set back to normal positions.**

- **Other Crane Components**

- Walkway with ladders and fall protection
 - This is used for crane service, access to controller tether, emergency controls, and general access to opposite side of vehicle.



- Stabilizers and pads
 - Pads should be used when there is an unstable ground.

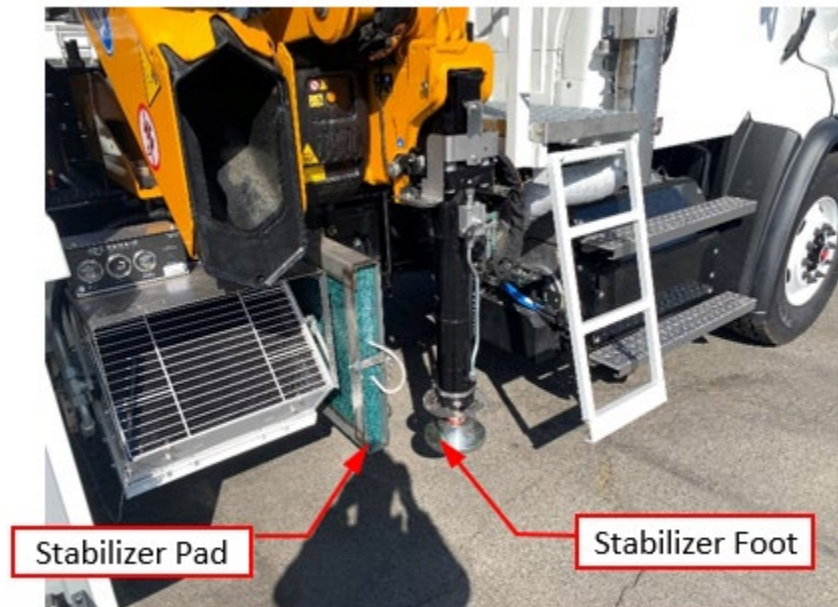

- Auger Storage

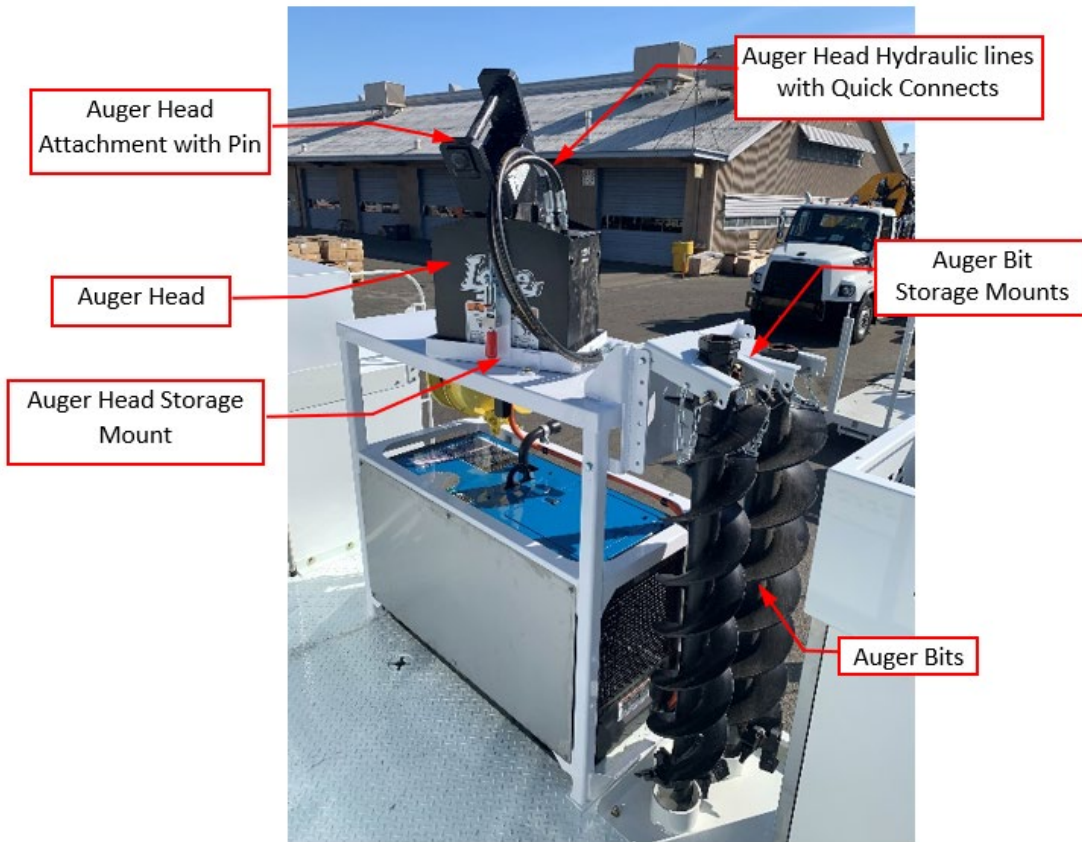

- When securing the auger head, be sure the clamp handle is fully locked.



Under Deck Compressor Pneumatic Air System:

The underdeck compressor is powered by the transmission PTO via driveline. The system is designed to output 185CFM @100psi continuously at 1200 RPM engine speed. The system also outputs 125CFM@100psi at 900RPM engine speed when being used in conjunction with the crane PTO. The system is designed to automatically shut off if over temperature or over pressure is detected.

- Components
 - o Compressor system
 - Vanair PTO Shaft Driven Air Compressor

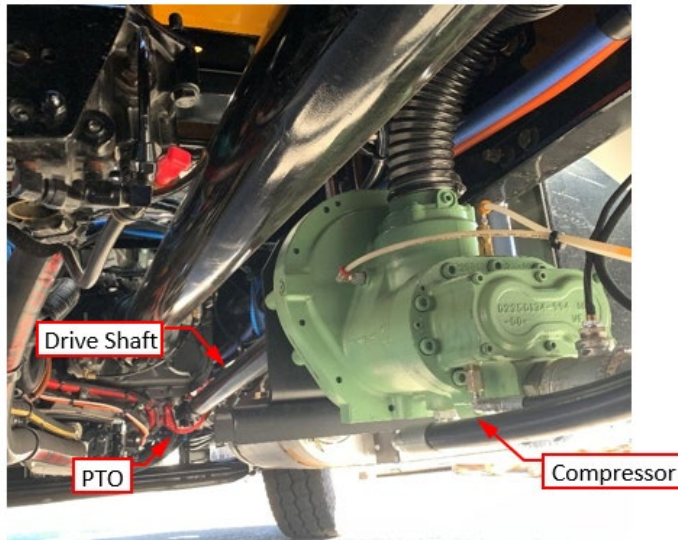

- o Oil water separator tank



- Oil Sight Gauge

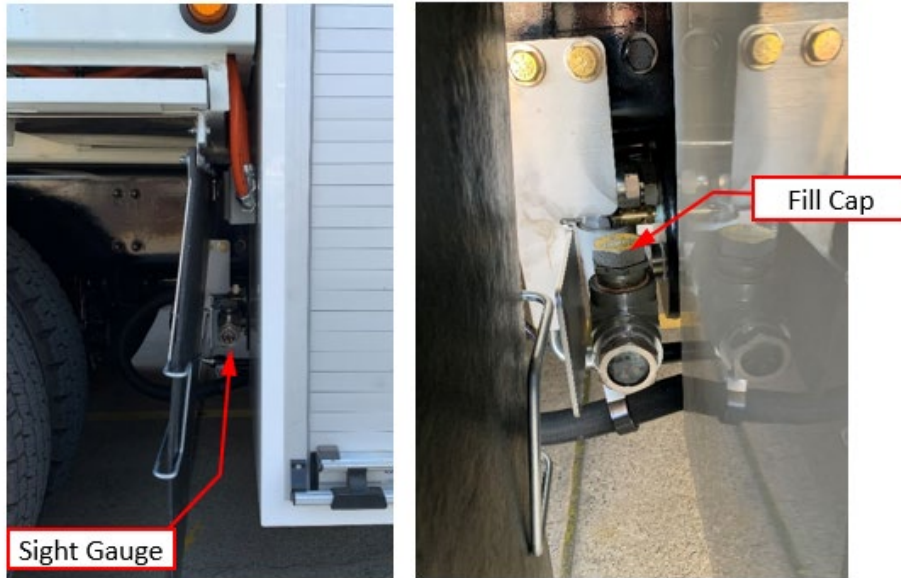

- Gauge Panel



- Oil Cooler



- Output Air Filter



- Intake Air Filter



- Water Separator



Front Work Station



Rear Driver Side

- Front work station



- Rear passenger side

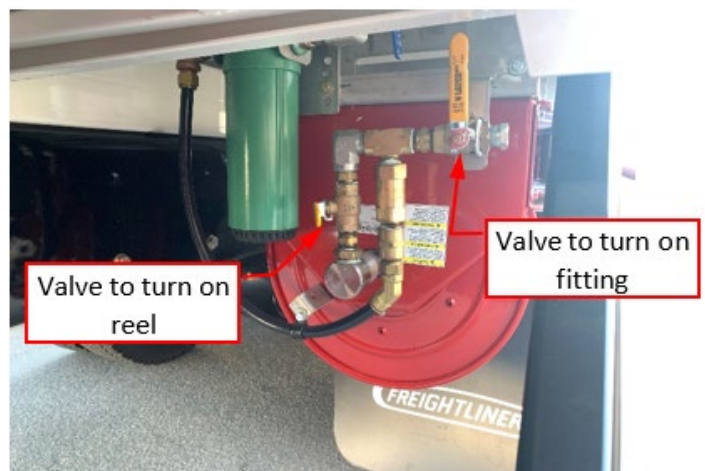

- Rear Diver side

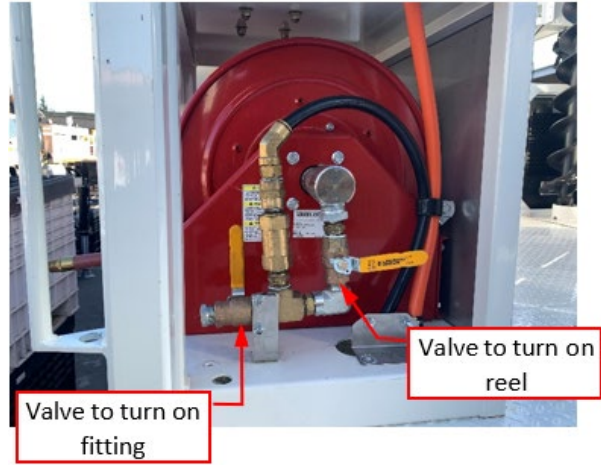

- **General Operation:**

See Vanair operator's manual for in depth operations

- Ensure you are on stable and level ground.
- Check oil level at Sight Gauge. Oil level should be at center of gauge.
- Engage PTO: See PTO operation on next page.
- Slowly open the Vanair Service valve at the front or rear station.

- Vanair Rear service engagement valve is located on the passenger side air reel.



- Vanair Front service engagement valve is located behind the front bumper near the front wheel well.



- Open required air function valve
 - Depending on the work require the options are hose reel or open airline (plug installed).
- Once complete shut off all air valves and disengage the PTO.
 - The vanair system will go into a bleed down mode to release remaining air in the system. An air release sound can be heard from under the truck.
- Vanair reference video:
 - Online video Operation and maintenance:
<https://www.youtube.com/watch?v=M-Q4ElwqUxY>
*electronic controller system(v-tec) not included with these units.
*units are limited to 100psi only.



CAUTION

- If the compressor PTO is on and there is an over-pressure or over-temperature condition, the engine will shut down.
- Do not switch the PTO on and off repeatedly. This can cause damage to the PTO and compressor.
- Wait for the Vanair system to bleed down prior to reengaging the PTO. Not doing so can cause damage to the PTO and compressor.
- Always disengage the PTO prior to switching off the vehicle
- Do not restart engine with PTO switch on.
- Never check the compressor oil level while running. Wait 5 minutes to check oil if the compressor was running.
- Always slowly open the service valve when beginning operation. Rapid flipping of the valve could cause damage to the separator element.
- Review the Vanair instruction manual for full detail on the hazards using this system

- **PTO Operation**



- To engage PTO
 - Set Parking Brake
 - Press and hold Foot Brake
 - Shift to “D” Drive
 - Switch PTO to on position
 - Shift to “N” Neutral
 - Slowly let go of foot brake (PTO will now engage and engine speed will automatically raise to 1200 RPM)
 - Note: If using in combination with crane PTO RPM will be set to 900 RPM and compressor output will be limited to 125cfm.
- To disengage PTO
 - Press and hold the footbrake and switch the PTO to the off position
 - Slowly let go of the footbrake (PTO will ramp down the RPM’s and disengage)

- **PTO Safety Interlocks**

- If any of the PTO switches are on when trying to turn on the truck, after the truck starts the indicator will flash until the switch is turned off. This prevents grinding of PTO if someone accidentally leaves the switch on after turning off the truck.
- PTO has 2 preset speeds: 900 rpm any time crane PTO is engaged, 1250 rpm only when JUST THE COMPRESSOR PTO is on. No need to press a switch, truck will change speeds automatically.
- Any time truck is shifted out of neutral, parking brake released, or foot put on the brake pedal, truck will drop to idle and any engaged PTO will disengage.

- **General Maintenance:** See Vanair operator’s manual.

Pressurized Water Tank System:

Theory of operation:

Air from the trucks pneumatic system is used to pressurize the water tank. The air pressure pushes the water in the tank through the water lines to the hose bib or water hose reels.

- Components

- Aluminum 100 Gallon Water Tank
 - Tank fill is a rubber flapper assembly on top of the water tank.
 - To fill push flapper assembly down and add water.
 - Water level indicates the amount of water used of the 100 gallon tank.

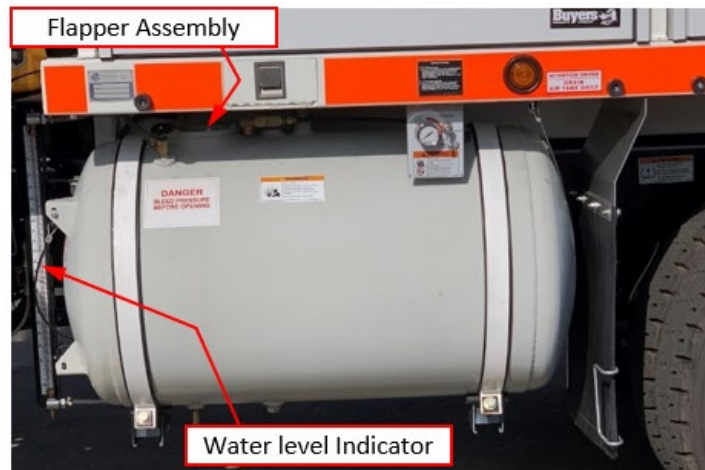

- Three-way Air valve
 - In the “Pressurize” position air is allowed to charge the water tank.
 - In the Off position air is shut off
 - In the “Discharge position” air is vented to atmosphere.



- Pressure regulator
 - Located behind three-way air valve

- Pressure from the trucks pneumatic system passes through the regulator which limits the air pressure used for the water system to 55 psi above ambient air pressure. The regulator is adjustable. Regulator should be set to a maximum of 55 psi.
 - Pressure gauge
 - Located on three-way air valve
 - Pressure of the air in the tank is displayed on the air pressure gauge.
 - Pressure protection valve
 - Located in top of the water tank.
 - Air pressure in the water tank can be increased by heating due to sunlight or other sources. The pressure protection valve is a poppet set to vent pressure to atmosphere if pressure rises above 60 psi.

- Water hose bibs
 - ¾" Hose Bibs
 - Locations: Mid body driver side and passenger side and passenger side front bumper
 - To operate turn hose bib valve counter clockwise.



- Water hose reels
 - 50 feet of ¾" water hose.
 - Two at the rear at each side.
 - To operate open ¾" ball valve located on the inside center of each reel.



- Operation
 - o Charge System
 - Place handle in the pressurize position. Pressure should reach up to 55psi.



CAUTION

- Operation will drain water tank air system and will shut off once water system air is all used. It is advised that the vehicle be turned on periodically to recharge water system tank.

- o Discharge System
 - Place handle in the exhaust position until the system is fully discharged
 - Once fully discharged, place handle in the off position



WARNING

- Burst Hazard
- Regulator maintains proper pressure
- Never tamper with or remove pressure regulator or relief valve.
- Never pressure test without water
- Bursting tank may injure or kill.
- Always discharge the air form the tank prior to driving.
- Inspect tank daily. If damaged replace immediately.

Generator/Welder:

Miller Bobcat 250 Output Range is 40 - 250A for AC stick/TIG and DC stick/TIG welding, as well as 17-28 V MIG/flux-cored Welding. Generator Output 11,000 Watts Peak, 9500 Watts continuous.

Generator/welder is independent and does not require truck ignition to be on.



- Components
 - o Generator/Welder
 - o Fuel system
 - Diesel fuel is tapped into the truck diesel fuel system.



- Generator/Welder will shut off when the trucks fuel tank is low. This will leave approximately 1/8 to 1/4 fuel in the trucks fuel tank.
- Read and understand the miller bobcat 250 diesel manual prior to operation.
 - o <https://www.millerwelds.com/support/manuals-and-parts>
- o Battery
 - Welder/Generator is linked to truck system battery.
- o Neutral Ground to Frame Wire
 - Do not remove green wire attached to face of miller bobcat 250.
 - Inspect regularly for damage.
- o Welder leads
 - Welder leads are in the Welder cabinet with the large roll up door.
- General Operation: See Miller operation manual for in depth operation.

AC Electrical Outlets:

This vehicle is equipped with five separate power outlets powered by the welder/generator unit.



DANGER

- Danger high voltage electrical shock hazard
 - Inspect cord and connections for damage prior to operation. Replace frayed or damage lines.
-
- 50 foot long AC cord reels are located on the passenger side above the welder/generator unit and on the driver side in the reel cabinet. Holsters are provided for the outlet stowage.



- In cabinet power is located in the top deck toolboxes that open to the inside deck.



- Front Workstation outlet at front bumper



Oxygen Acetylene System:

- Components
 - o Passenger side welders cabinet
 - Oxygen and Acetylene tank storage
 - Hose reel with quick disconnect fittings



- o Driver side body compartment
 - Quick disconnect fittings



Liftgate:

Tommygate Model: RLC89-1654S37TP06-20LL

- 1600lb capacity Liftgate



- Standard Operation
 - o Truck ignition switch must be keyed on.
 - o Release storage lock mechanism.



- o Use Up/Down switch
 - Two switches are located on rear right and left sides of the liftgate accessible from the ground.
 - One switch is located on the upper passenger side rear post above the deck.
- o Liftgate Platform will pivot out and drop down.



CAUTION

- Always stand clear of platform area

- Features

- o Three switch locations

- One on each side of the liftgate located so someone at ground level can reach.
- One at the deck level so someone on the deck can use the liftgate.



- o Vice Pockets

- Two vice pocket were added to the end of the liftgate to provide a location for a removable work platform or vice.



- o Auto stow feature, pivots the platform up and down during operation.

- Operator will need to align the pivot roller bars by pushing them down to engage the auto stow feature

- o Anti-pinch bar feature

- A safety bar is located at the bottom end of the liftgate. When the bar is compressed it will automatically de-energize the liftgate and stop all movement. This is meant to prevent accidental crushing of loads or feet.

**WARNING**

- Always watch for traffic while deploying liftgate. Be sure area is clear.
- Liftgate hazards can result in crushing or falling
- Keep hands and feet clear of pinch points.
- If riding liftgate, make sure load is stable and footing is solid. Follow precautions listed in Tommygate owner's manual.
- Do not disable or interfere with any safety feature on this liftgate. Doing so may cause a hazardous situation.

Front Workstation:

- The front work station consists of:
 - o Water Hose Bib
 - o Hydraulic Air Line
 - o 120V AC Outlet
 - o Vice pocket Mount
 - Location for removable work platform or vice.

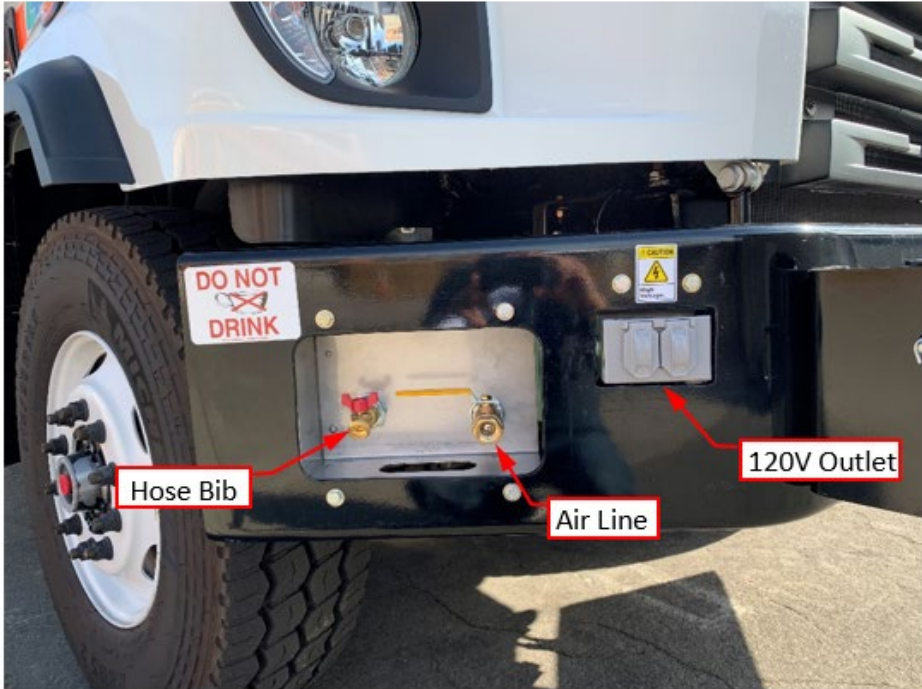

Lighting Systems:

This vehicle is equipped with various lighting systems that are all activated from the cab switch panel located at the driver side head board.



- Light Bar



- Rear Flashers



- Work lights
 - o Drivers Side



- Passenger Side



- Each work light can be independently turned on and off by a switch in the rear of the light.



- Cabinet/toolbox Lighting



- Stabilizer lighting



- Deck Lighting
 - o Turned on by cabinet light switch in cab.



- Welder night illumination lighting
 - o Turned on by cabinet light switch in cab.



Storage:

- All Storage boxes are keyed alike and include LED lighting.
- Components
 - o Diver side with 48" tool boxes



- o Welders Cabinet and Top Tool Box



- Passenger side roll up door cabinet with tool basket
 - Located on the passenger rear



- Rear driver side underdeck tool box
 - Located on the driver side rear under deck.



- Cab console tool box with work surface and clip board.
 - Located between the seat in the cab.
 - Crane remote storage located inside.
 - Truck manuals located inside.



18 ft bed:

- Components
 - o Access Points:
 - Three access points to the bed of the truck; two in the rear on both sides, and one towards the front on the passenger side of the bed.



Rear Drivers Side



Front Passenger Side



Rear Passenger Side

- o Ladder and Fall protection:
 - Each access point has a stowable ladder and a chain to prevent falls.

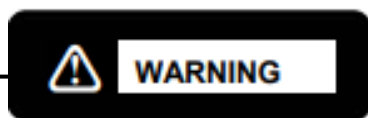

- Always keep chains on access points closed while ladder is not in use.
- Always stow ladder before moving vehicle.

- Cross body compartment boxes:
 - Two cross body boxes are provided in the body.



- Tie downs:
 - Tie downs are located at various places on the top of the bed, they are designed to fit 3/8" chain.

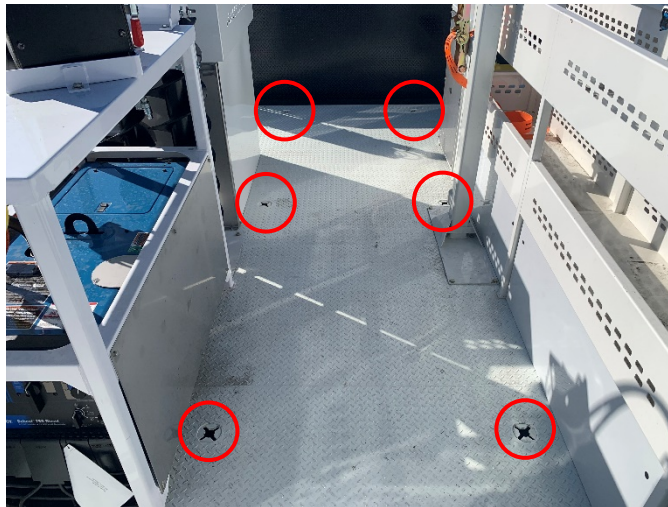

Fire Extinguishers:

- Driver side under walkway
 - o 5 lb fire extinguisher



- Passenger side in welder's cabinet
 - o 10 lb fire extinguisher



Cone holders:

- Located on the front bumper:
 - o Cone holders are designed to pivot down by manually removing the lock pins. This is necessary when tilting the engine bay cover to access the engine compartment.



Bridge Truck Options:

- Bridge truck options include:
 - o Cement Mixer
 - o Double Stack Tool Boxes
 - o A toolbox on top of the welder's cage.

